

M91™

An affordable All-in-One: a smart PLC with a textual HMI and keyboard, plus an onboard I/O configuration; expand up to 150 I/Os

Features:

HMI

- Up to 80 user-designed screens
- Multilingual: supports over 15 languages and 20 graphic symbols
- Scroll between pre-programmed recipes/menus
- Memory and communication monitoring via HMI - No PC needed

PLC

- Shaft-encoder inputs and PWM outputs
- Direct temperature inputs
- Auto-tune PID, up to 4 loops
- Date & Time-based control
- Database
- Print utilities
- Full source upload

Communication

- SMS messaging via GSM
- Remote access utilities
- PC access via MODBUS or OPC server
- Supports MODBUS protocol
- CANBus (in C models only)
- User-defined ASCII strings, enable communication with external devices
- RS232/RS485 built-in port



M91

M91										
Article Number	M91-2-R1	M91-2-R2C	M91-2-R6C	M91-2-R34	M91-2-T1	M91-2-T38	M91-2-T2C	M91-2-UN2	M91-2-UA2	M91-2-RA22
	10 Digital 1 Analog Inputs 6 Relay Outputs	10 Digital 2 Analog Inputs 6 Relay Outputs	6 Digital 6 Analog Inputs 6 Relay Outputs	20 Digital 2 D/A ¹ Inputs 12 Relay Outputs	12 Digital Inputs 12 Transistor Outputs	22 Digital Inputs 16 Transistor Outputs	10 Digital 2 D/A ¹ Inputs 12 Transistor Outputs	10 Digital 2 D/A/PT100/TC ¹ Inputs 12 Transistor Outputs	10 Digital 2 D/A/TC ¹ Inputs 10 Transistor 2 Analog Outputs	8 Digital, 2 D/A 2 PT100/TC/ Digital ¹ Inputs 8 Relay 2 Analog Outputs
Inputs										
Digital pnp/npn	10	10	6	22	12	22	12	12	12	12
HSC/Shaft-Encoder/ Max. Freq. Measurer ²	3 10kHz 16-bit	3 10kHz 16-bit	1 10kHz 16-bit	3 30kHz ³ 16-bit	2 10kHz 16-bit	2 30kHz ³ 16-bit	3 10kHz 16-bit	2 10kHz 16-bit	1 30kHz ³ 16-bit	1 30kHz ³ 16-bit
Analog	1 10-bit 0-10V, 0-20mA 4-20mA	2 10-bit 0-10V, 0-20mA 4-20mA	6 10-bit 2 0-10V 0-20mA, 4-20mA and 4 0-20mA 4-20mA	2 10-bit 0-10V, 0-20mA 4-20mA	None	None	2 10-bit 0-10V, 0-20mA 4-20mA	2 14-bit 0-10V, 0-20mA 4-20mA	2 14-bit 0-10V, 0-20mA 4-20mA	2 14-bit 0-10V, 0-20mA 4-20mA
Temperature Measurement	None	None	None	None	None	None	None	2 PT100/TC or 2 TC	2 TC or 2 TC	2 PT100/TC and 2 PT100/TC
Outputs										
Digital	6 relay	6 relay	6 relay	12 relay	12 pnp	16 pnp	12 pnp	12 pnp	10 pnp	8 relay
High-Speed Outputs/ PWM ⁴	None	None	None	None	2, first 2 outputs can function as HSO, 0.5kHz maximum					None
Analog	None	None	None	None	None	None	None	None	2 12-bit: 0-10V, 4-20mA	2 12-bit: 0-10V, 4-20mA
I/O Expansion	I/Os may be added via expansion port									
Program										
Application Memory	36K (virtual) Ladder code capacity									
Memory Operands	256 coils, 256 registers, 64 timers									
Database	1024 integers, (indirect access)									
Operator Panel										
Type	STN LCD									
Display Size	2 lines x 16 characters									
Keys	15 keys									
General										
Power Supply	12/24VDC	12/24VDC	24VDC	24VDC	12/24VDC	24VDC	12/24VDC	12/24VDC	24VDC	24VDC
Battery	7 years typical at 25°C, battery back-up for all memory sections and RTC									
Clock (RTC)	Real-time clock functions (date and time)									
Environment	IP65/NEMA4X (when panel mounted)									
Standard	CE, UL Many of our products are also UL Class 1 Div 2 and GOST certified - please contact Unitronics									

¹ In these models certain inputs are adaptable, and can function as either digital, analog, and in certain models also as thermocouple or PT100. Using adaptable inputs reduces the amount of free digital inputs. For example, M91-2-UA2 offers 12 digital inputs. Implementing 2 TC inputs requires 4 digital inputs, leaving 8 free.

² Certain inputs can function as high-speed counters, shaft-encoder inputs, or normal digital inputs.

³ This specification depends on cable length.

⁴ Certain outputs can function as high-speed or PWM outputs.

I/O Expansion Modules

CE/UL

Expand your system with local or remote I/O expansion modules.

Vision series support both local & remote I/O modules. M91 supports local modules only.

Digital Modules

IO-DI8-T08	IO-DI8-R04	IO-DI8-R08	EX90-DI8-R08 ³	IO-DI16
24VDC* 8 Digital Inputs , pnp/npn, including one High-speed Counter 8 pnp Transistor Outputs	24VDC* 8 Digital Inputs , pnp/npn, including one High-speed Counter 4 Relay Outputs	24VDC* 8 Digital Inputs , pnp/npn, including one High-speed Counter 8 Relay Outputs	24VDC 8 Digital Inputs , pnp, including one High-speed Counter 8 Relay Outputs	24VDC* 16 Digital Inputs , pnp/npn, including one High-speed Counter
IO-T016	IO-R08	IO-R016	IO-DI8ACH	
24VDC 16 pnp Transistor Outputs	24VDC* (power supply) 8 Relay Outputs	24VDC* (power supply) 16 Relay Outputs	110/220 VAC 8 AC Inputs	

*Also available as 12VDC – contact us for part number

High-speed Remote I/O Module

EXF-RC15 ^{2,5}
24VDC 9 Digital Inputs pnp/npn, including 3 high-speed counter, 4 npn Transistor Outputs , may function as high-speed PWM/PTO, 2 relay outputs

Analog, Temperature and Weight/Strain Measurements

IO-AI4-A02	IO-PT400	IO-PT4K
24VDC (power supply) 4 Analog Inputs 12-bit, 0-10V, 0-20mA, 4-20mA, 2 Analog Outputs , 12-bit+sign, ± 10V, 0-20mA, 4-20mA	4 PT100/NI100/NI120 Inputs Range PT100: -50°C ÷ 460°C (-58°F ÷ 860°F) Range NI100: -50°C ÷ 232°C (-58°F ÷ 449°F) Range NI120: -50°C ÷ 172°C (-58°F ÷ 341°F) 12-bit	4 PT1000/NI1000 Inputs Range PT1000: -50°C ÷ 460°C (-58°F ÷ 860°F) Range NI1000: -50°C ÷ 232°C (-58°F ÷ 449°F) 12-bit
IO-A06X	IO-LC1 ⁴	IO-LC3 ⁴
24VDC (power supply) 6 Isolated Analog Outputs 0-10V, 0-20mA, 4-20mA 12-bit	12/24VDC (Power Supply) 1-3 Loadcell / Strain gauge Inputs Input voltage ranges: ± 20mV, ± 80mV Excitation: AC/DC 1 Digital pnp Input 2 pnp Outputs Not supported by all PLCs	8 Thermocouple/ Analog Inputs T/C J, K, T, B, E, N, R, S, 0.1 ⁰ Resolution, 0-10V, 0-20mA, 4-20mA, 12/14-bit

I/O Expansion Module Adapters

EX-A2X ¹
Local I/O module adapter. Galvanic isolation. Up to 8 modules may be connected to a single PLC ¹ . Supports both 12/24 VDC
EX-RC1 ^{1,5}
Remote I/O module adapter, via CANbus. Connect multiple adapters to a single PLC; connect up to 8 modules per adapter. Supports both 12/24 VDC.

¹ Number of supported I/Os & I/O modules varies according to PLC model.

² The EXF-RC15 functions as a CANbus node in a Vision UniCAN network. The EXF-RC15 is stand-alone and does not support I/O Expansion Modules.

³ The EX90 is housed in an open casing. Only one EX90 can be connected per PLC, as a single expansion module; Expansion adapter not required.

⁴ IO-LCx models are supported by the M91 & Vision series. Not supported by the M90 series.

⁵ Supported by Vision series. Not supported by M91 series.

Functions as both I/O module and adapter*

IO-D16A3-R016	IO-D16A3-T016	EX-D16A3-R08	EX-D16A3-T016
24VDC, 16 Digital Inputs pnp/npn, including two High-speed Counters, 3 Analog Inputs , 10-bit, 0-20mA, 4-20mA, 16 Relay Outputs	24VDC, 16 Digital Inputs pnp/npn, including one High-speed Counter, 3 Analog Inputs , 10-bit, 0-20mA, 4-20mA, 15 pnp + 1 pnp/npn Transistor Outputs including 1 HSO	24VDC, built-in Expansion Module Adapter, 16 Digital Inputs , pnp/npn, including two High-speed Counters, 3 Analog Inputs 10-bit, 0-20mA, 4-20mA, 8 Relay Outputs	24VDC, built-in Expansion Module Adapter, 16 Digital Inputs , pnp/npn, including one High-speed Counter, 3 Analog Inputs 10-bit, 0-20mA, 4-20mA, 15 pnp + 1 pnp/npn Transistor Outputs including 1 HSO

*Functions as local adapter. Can support up to 7 I/O modules

M91-2-T1

Art. No. 1\$, ++(

12/24 VDC, 12 pnp/npn digital inputs, 2 high-speed counter/shaft encoder inputs, 12 transistor outputs, I/O expansion port, RS232/RS485 port

Power supply	
Permissible range	12VDC or 24VDC
Maximum current consumption	10.2VDC to 28.8VDC with less than 10% ripple 80mA@24VDC (pnp inputs) 140mA@12VDC (pnp inputs) 170mA (npn inputs)
Digital inputs	
Nominal input voltage	12VDC or 24VDC. See Notes 2 and 3.
Input voltages for pnp (source):	
For 12VDC	0-3VDC for Logic '0' 8-15.6VDC for Logic '1'
For 24VDC	0-5VDC for Logic '0' 17-28.8VDC for Logic '1'
Input voltages for npn (sink):	
For 12VDC	8-15.6VDC/<1.2mA for Logic '0' 0-3VDC/>3mA for Logic '1'
For 24VDC	17-28.8VDC/<2mA for Logic '0' 0-5VDC/>6mA for Logic '1'
Input current	4mA@12VDC 8mA@24VDC
Input impedance	3K Ω
Response time (except high-speed inputs)	10mS typical
Galvanic isolation	None
Input cable length	Up to 100 meters, unshielded
High-speed counter	
	Specifications below apply when inputs are wired for use as a high-speed counter input/shaft encoder. See Notes 4 and 5.
Resolution	16-bit
Input freq.	10kHz max.
Minimum pulse	40 μ s

Notes:

- All 12 inputs can be set to pnp (source) or npn (sink) via a single jumper and appropriate wiring.
- All 12 inputs can function in 12 VDC or 24 VDC; set via a single jumper and appropriate wiring.
- npn (sink) inputs use voltage supplied from the controller's power supply.
- Inputs #0 and #2 can each function as either high-speed counter or as part of a shaft encoder. In each case, high-speed input specifications apply. When used as a normal digital input, normal input specifications apply.
- Inputs #1 and #3 can each function as either counter reset, or as a normal digital input; in either case, specifications are those of a normal digital input. These inputs may also be used as part of a shaft encoder. In this case, high-speed input specifications apply.



Warnings:

- Unused pins should not be connected. Ignoring this directive may damage the controller.
- Improper use of this product may severely damage the controller.
- Refer to the controller's User Guide regarding wiring considerations.
- Before using this product, it is the responsibility of the user to read the product's User Guide and all accompanying documentation.

Power supply, pnp (source) inputs

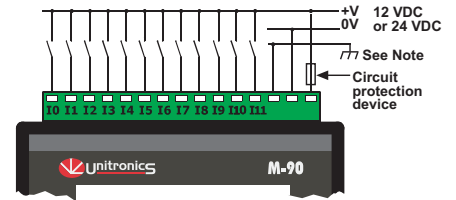

Note:

To avoid electromagnetic interference, mount the controller in a metal panel/cabinet and earth the power supply. Earth the power supply signal to the metal using a wire whose length does not exceed 10cm. If your conditions do not permit this, do not earth the power supply.

npn (sink) inputs

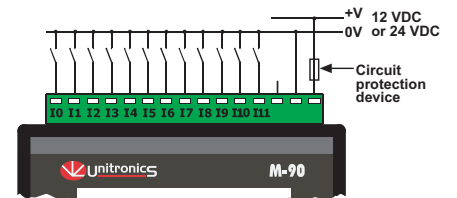

pnp (source) high-speed counter

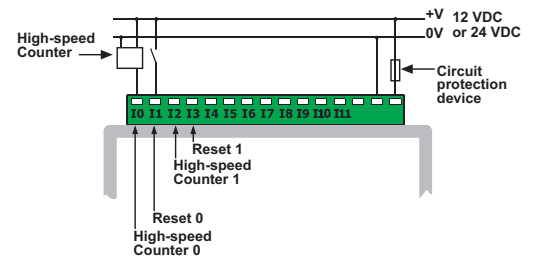

npn (sink) high-speed counter

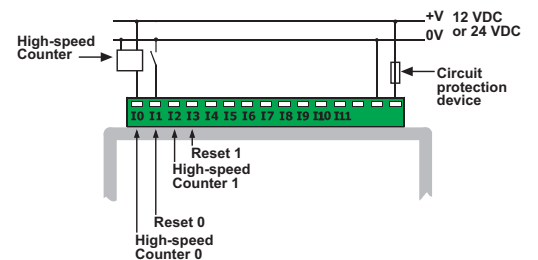

Shaft encoder

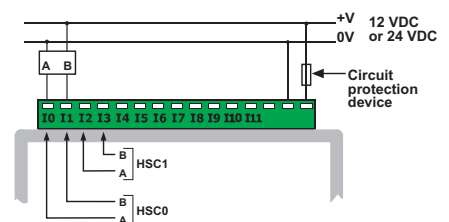

Digital outputs	12 pnp (source) outputs 12VDC or 24VDC
Output type	P-MOSFET (open drain)
Isolation	None
Output current	0.5A max. Total current: 3A max.
Max. frequency for normal outputs	50Hz (resistive load) 0.5Hz (inductive load)
High speed output maximum frequency	2kHz (resistive load) See Note 1.
Short circuit protection	Yes
Short indication	by software
On voltage drop	0.5VDC maximum
Power supply for outputs	
Operating voltage	10.2 to 28.8VDC
Nominal operating voltage	12VDC or 24VDC

Note:

1. Output #0 and Output #1 may be used as high-speed outputs.

Outputs connection

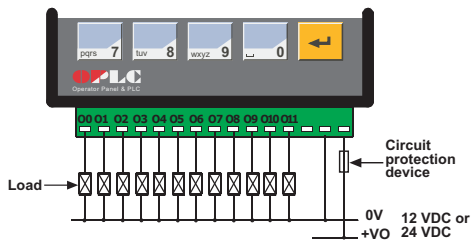

Display	STN, LCD display
Illumination	LED yellow-green backlight
Display size	2 lines, 16 characters long
Character size	5 x 8 matrix, 2.95 x 5.55mm

Keypad	Sealed membrane
Number of keys	15

PLC program	
Ladder Code Memory (virtual)	36K
Memory Bits (coils)	256
Memory Integers (Registers)	256
Timers	64
Execution time	12µsec. for bit operations
Database	1024 integers (indirect access)
HMI displays	80 user-designed displays
HMI variables	64 HMI variables are available to conditionally display and modify text, numbers, dates, times & timer values. The user can also create a list of up to 120 variable text displays, totaling up to 2K.

RS232/RS485 serial port	Used for: <ul style="list-style-type: none"> • Application Download/Upload • Application Testing (Debug) • Connect to GSM or standard telephone modem: <ul style="list-style-type: none"> - Send/receive SMS messages - Remote access programming • RS485 Networking
RS232 (see note)	1 port
Galvanic isolation	None
Voltage limits	±20V
RS485 (see note)	1 port
Input voltage	-7 to +12V differential max.
Cable type	Shielded twisted pair, in compliance with EIA RS485
Galvanic isolation	None
Baud rate	110 – 57600 bps
Nodes	Up to 32

Note:

RS232/RS485 is determined by jumper settings and wiring as described in the document "M91 RS485 Port Settings" packaged with the controller.

I/O expansion port	Up to 64 additional I/Os, including digital & analog I/Os, RTD and more.
---------------------------	--

Miscellaneous	
Clock (RTC)	Real-time clock functions (Date and Time).
Battery back-up	7 years typical battery back-up for RTC and system data.
Weight	266g (9.37 oz.)
Operational temperature	0 to 50°C (32 to 122°F)
Storage temperature	-20 to 60°C (-4 to 140°F)
Relative Humidity (RH)	5% to 95% (non-condensing)
Mounting method	DIN-rail mounted (IP20/NEMA1) Panel mounted (IP65/NEMA4X)

The tables below show how to set a specific jumper to change the functionality of the inputs. To open the controller and access the jumpers, refer to the directions at the end of these specifications.

Important:

Incompatible jumper settings and wiring connections may severely damage the controller.

JP8

Input type (for all digital inputs)

To use as	JP8
npn (sink)	A
pnp (source)*	B

JP9

Input voltage (for all digital inputs)

To use as	JP9
12VDC	A
24VDC*	B

*Default factory setting

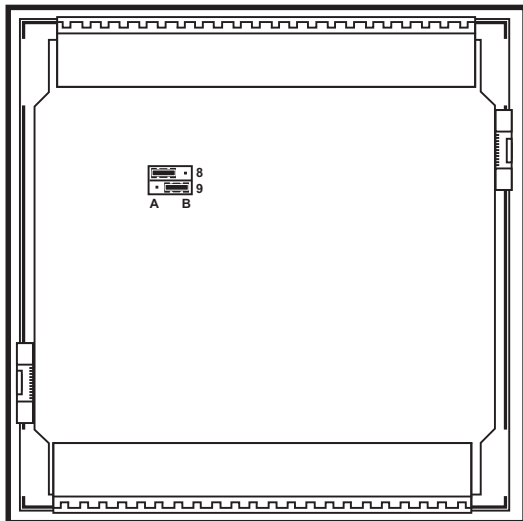

In this figure, the jumper settings will cause the inputs to function as npn, 24VDC digital inputs

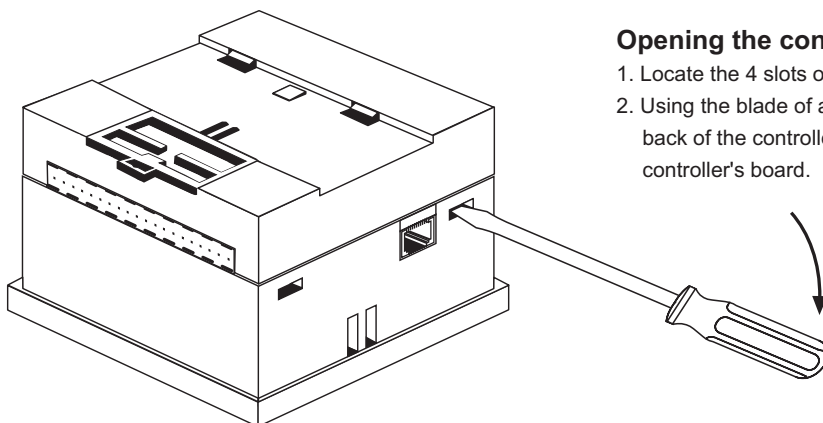

Opening the controller enclosure

1. Locate the 4 slots on the sides of the enclosure
2. Using the blade of a flat-bladed screwdriver, gently pry off the back of the controller as shown in the figure below, exposing the controller's board.

Unitronics reserves the right to revise this publication from time to time and to amend its contents and related hardware and software at any time.

Technical updates (if any) may be included in subsequent editions (if any).

Unitronics product sold hereunder can be used with certain products of other manufacturers at the user's sole responsibility.