

UCR-ST-B8 Router

The Unitronics UCR-B8 enable Unitronics PLC products to communicate via mobile networks (4G).

Highlights:

1. 3 Ethernet LAN ports and 1 WAN (configurable can act as LAN)
2. Embedded GPS receiver.
3. Wireless LAN access point or client to existing network.
4. Embedded send / receive SMS messages directly from UniStream PLCs.
5. RS232, RS485 and USB interfaces with embedded Serial-To-Ethernet functionality.
6. I/O:
 - a. 3 Digital Inputs
 - b. 1 Analog Input
 - c. 2 Digital Outputs
 - d. 1 Relay Output

Note: UniLogic SMS embedded support from Ver. 1.29 and above.

Package Content

#	Description	Quantity	Unitronics P/N
1	UCR-B8 Router	1	
2	Power cable, 2m, 4 pins terminal block	1	UCR-ACC-01
3	LTE antenna (magnetic mount, SMA male, 3 m cable)	2	UCR-ACC-02
4	WiFi antenna (magnetic mount, RP-SMA male, 1.5 m cable)	2	UCR-ACC-03
5	GNSS antenna (adhesive , SMA male, 3 m cable)	1	UCR-ACC-04
6	RS485 and I/O terminal blocks	1	UCR-ACC-05
7	Ethernet cable (1.5 m)	1	
8	Quick Start Guide	1	

SIM Card

SIM Card Insertion

- 1 Pull the SIM needle out of the router
- 2 Push the SIM holder button with the SIM needle
- 3 Pull out the SIM holder
- 4 Insert your SIM card into the SIM holder
- 5 Slide the SIM holder back into the router



Front View

#	Description
1	LAN Ethernet ports
2	WAN Ethernet port
3	LAN LEDs
4	WAN LED
5	RS485 connector
6	Power connector
7	RS232 connector
8	Input / Output connector
9	Power LED
10	Mobile connection status LED
11	Mobile signal strength indication LEDs



Back View

#	Description
1	Mobile antenna connectors
2	GPS antenna connector
3	USB connector
4	WiFi antenna connectors
5	Reset button
6	SIM card slots



LED: Status Indication

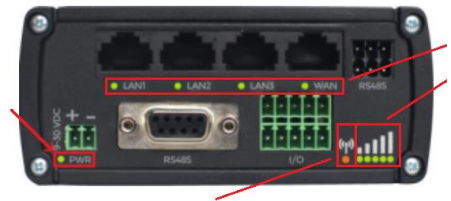

Power LED

ACTION	DESCRIPTION
LED turned ON	Router is powered up
LED turned OFF	Router is not powered up

Ethernet Port LEDs

ACTION	DESCRIPTION
LED turned ON	Operating as a 10/100 Mbps connection
LED turned OFF	No link established
LED blinking	Connection established and there is activity on this port (data being transferred)
LEDs light up and turn OFF in sequence from WAN port to LAN1 port	The router is in the bootloader menu state*

* The bootloader menu is a special router state from which certain upgrades can be performed

Connection Status LED

The LED displays the router's current connection state and network type

ACTION	DESCRIPTION
Green and red blinking alternatively ever 500 ms	No SIM or bad PIN
Green, red and orange blinking alternatively every 500 ms	Connecting to GSM
Red blinking every 1 sec	Connected 2G, no data session established
Orange blinking every 1 sec	Connected 3G, no data session established
Green blinking every 1 sec	Connected 4G, no data session established
Red lit and blinking rapidly while data is being transferred	Connected 2G with data session
Orange lit and blinking rapidly while data is being transferred	Connected 3G with data session
Green lit and blinking rapidly while data is being transferred	Connected 4G with data session

Signal Strength LEDs

Each lit up LED represents a different value of the router's current signal strength in RSSI:

NO. OF LIT UP LEDs	SIGNAL STRENGTH VALUE
0	≤ -111 dBm
1	-110 dBm to -97 dBm
2	-96 dBm to -82 dBm
3	-81 dBm to -67 dBm
4	-66 dBm to -52 dBm
5	≥ -51 dBm

All 5 LEDs are lit up after pressing and holding the reset button to initiate a factory reset.

Powering Options

Power Connector

4 pin power connector:

Pin	Description	Direction
1	Power	Red
2	Ground	Black
3	Digital Input	Green
4	Digital Output	White

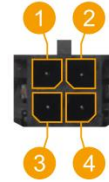

Passive Power Over Ethernet

The device may also be powered by an Ethernet cable via the LAN1 port:
(Do not use in other ports!)



RS485 Connector Pinout

Pin	Description
D_P	Positive signal
D_N	Negative signal
R_P	Shortcut to D_R
R_N	Shortcut to D_N
Ground	Signal ground

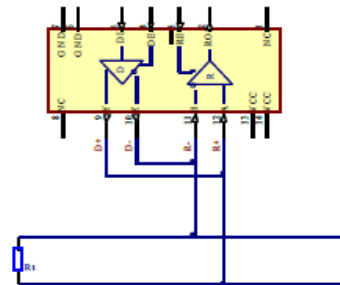
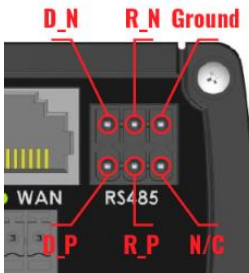

Network termination- Place 120Ω termination resistor at each end of the network

RS232 Connector Pinout

D-type 9 pin female connector:

Pin	Description	Direction
1	DCD (Data Carrier Detect)	Output
2	RxD (Receive Data)	Output
3	TxD (Transmit Data)	Input
4	DTR (Data Terminal Ready)	Input
5	GND (Signal Ground)	-
6	DSR (Data Set Ready)	Output
7	RTS (Request to Send)	Input
8	CTS (Clear To Send)	Output
9	RING (Ring Indicator)	Output

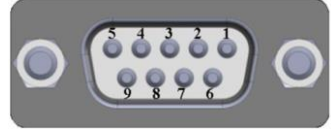

Input / Output Specification and Pinout

Associated Pins	Description
1, 6	Digital Input 1, 0-3VDC (Low 0-1.2V, High 1.8-3V)
2, 7	Digital Input 2, 0-30VDC (Isolated, Low 0-4V, High 9-30V)
9, 6	Analog Input 1, 0-24VDC / 0-20mA
3, 8, 4	Digital Output 1, 0-30VDC, 250mA (sink, Isolated)
5, 10	Relay Output 1, 0-24VDC / 0-40VAC, 4A

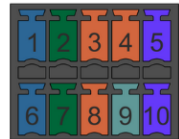

I/O Terminal Block Pinout	Description
1	Digital Input 1 (Input Signal)
2	Digital Input 2 (Input Signal)
3	Digital Output 1 (Output Signal)
4	Digital Output 1 (V+)
5	Relay Output 1 (COM)
6	Digital Input 1 and Analog Input 1 (GND)
7	Digital Input 2 (GND)
8	Digital Output 1 (GND)
9	Analog Input 1 (Input Signal)
10	Relay Output 1 (Output Signal)

Power Connector

Associated Pins	Description
3	Digital Input 1, 0-40VDC (Low 0-5V, High 8-40V)
4	Digital Output 1, 0-30VDC, 300mA (sink)

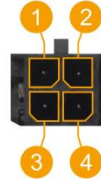

Mounting

Use the Din Rail bracket or M3 screws to mount the device.

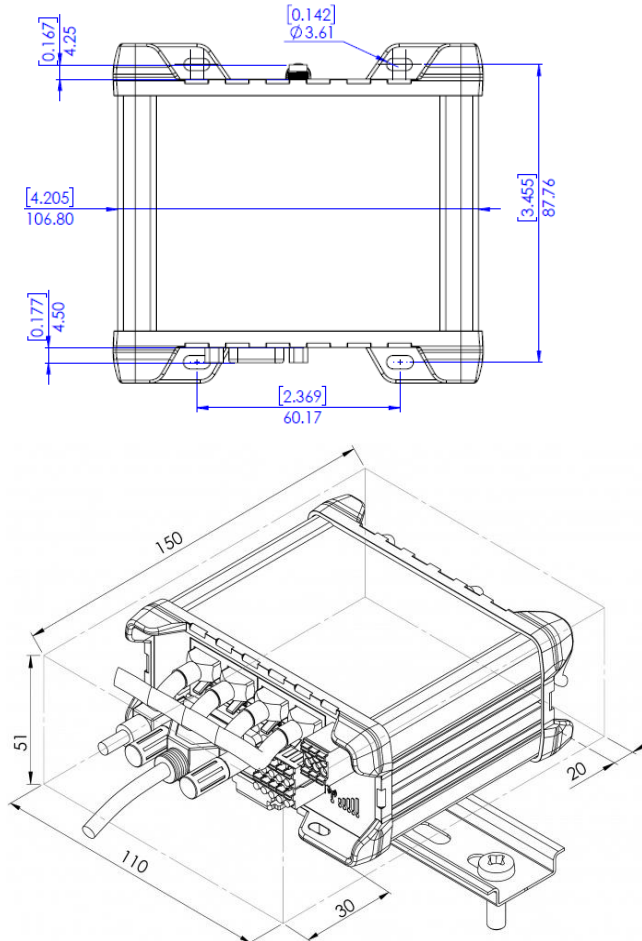

Technical Specifications

Power voltage range	9 – 30 VDC, 4 pin DC connector
Power consumption	< 7W
Power over Ethernet (passive)	Passive PoE over spare pairs. Possibility to power up through LAN1 port, not compatible with IEEE802.3af and 802.3at standards
Status LEDs	1 x bi-color connection status 5 x connection strength 4 x LAN status 1x Power
SIM card	2 x external SIM holders
Ethernet	4 x 10/100 Ethernet ports: <ul style="list-style-type: none"> - 1 x WAN (configurable as LAN) - 3 x LAN ports
Inputs	3 x Digital Inputs 1 Analog Input
Outputs	1 Relay, 24V, 4A, SPST 2 x Digital Open Collector Output
Connectors	1 x 4 pin DC, 4 x Ethernet 2 x Mobile SMA 2 x WiFi RP-SMA 1 x GPS SMA 1 x RS232 1 x 6 pin RS485 1 x 10 pin I/O USB 2.0
Mobile	4G (LTE) – Cat 4 DL up to 150 Mbps, UL up to 50 Mbps; DC-HSPA+; UMTS; TD-SCDMA; EDGE; GPRS
Housing	Aluminum housing, plastic panels
Dimensions	100 mm x 110 mm x 50 mm (3.94"x4.33"x1.97")
Weight	287 g (10.12 oz)
Storage and Operational temperature	-40 °C to 75 °C (-40°F to 167°F)

Unitronics product sold hereunder can be used with certain products of other manufacturers at the user's sole responsibility.

The information provided is subject to change without notice.

The information in this document reflects products at the date of printing. Unitronics reserves the right, subject to all applicable laws, at any time, at its sole discretion, and without notice, to discontinue or change the features, designs, materials and other specifications of its products, and to either permanently or temporarily withdraw any of the foregoing from the market.

All information in this document is provided "as is" without warranty of any kind, either expressed or implied, including but not limited to any implied warranties of merchantability, fitness for a particular purpose, or non-infringement. Unitronics assumes no responsibility for errors or omissions in the information presented in this document. In no event shall Unitronics be liable for any special, incidental, indirect or consequential damages of any kind, or any damages whatsoever arising out of or in connection with the use or performance of this information.

The tradenames, trademarks, logos and service marks presented in this document, including their design, are the property of Unitronics (1989) (R"G) Ltd. or other third parties and you are not permitted to use them without the prior written consent of Unitronics or such third party as may own them.