

General restrictions

- All examples and diagrams are intended to aid understanding, and do not guarantee operation. Unitronics accepts no responsibility for actual use of this product based on these examples.
- Please dispose of this product according to local and national standards and regulations.
- This product should be installed only by qualified personnel.

Environmental Considerations

- Do not install in areas with: excessive or conductive dust, corrosive or flammable gas, moisture or rain, excessive heat, regular impact shocks or excessive vibration, in accordance with the standards and limitations given in the product's technical specification sheet.
- Do not place in water or let water leak onto the unit.
- Do not allow debris to fall inside the unit during installation.
- Install at maximum distance from high-voltage cables and power equipment.

Installation - Din-Rail Module Mounting

1. Lift the white locking latch on the bottom of the module.
2. Press down the module lightly on the DIN rail until the lower ridge click onto the rail.
3. Close the latch to lock the module in.



How to Remove the Module from the DIN-Rail

1. Pull the white locking latch.



2. Pull the module off the rail.



Specifications

Items	Specification
Max. Expansions Module	Up to 63 slots The adapter is limited to process 192 data bytes for inputs and 192 data bytes for outputs. Each digital input/output point process data is 1 bit (minimum 1 byte per module if module data sized is less than 8 points) while each analog input/output is 2 bytes (8 inputs/outputs module will be 16 bytes of process data).
Max Length Bus Line	Up to 100m from Ethernet Hub/Switch with twisted CAT5 UTP/STP
Max. Nodes	Limited by Ethernet Specification.
Baud Rate	10/100Mbps, Auto-negotiation, Full duplex
Interface Connector	2 ports, RJ-45 socket
IP-Address Setup	DIP Switch or DHCP/BOOTP
IP-Address Range	xxx.xxx.xxx.1 ~ 253 (User area) xxx.xxx.xxx.254 ~ 255 (Reserved for IAP Function)
Indicator	6 LEDs 1 Green/Red, Module Status (MOD) 1 Green, Physical Connection (LINK) 1 Green, Exchange Data/Traffic Present (ACTIVE) 1 Green/Red, Expansion I/O Module Status (IOS) 1 Green, System Power Status 1 Green, Field Power Status 2 LEDs (each RJ45 Connector) 1 Yellow, Link/Active 1 Green, Not used
System Power	Supply voltage : 24VDC nominal Supply voltage range : 15~32Vdc

	Protection : <ul style="list-style-type: none"> • Output current limit (Min. 1.5A) • Reverse polarity protection
Power Dissipation	70mA typical @ 24VDC
Current for I/O Module	1.5A @ 5VDC
Isolation	System power to internal logic : Non-isolation System power I/O driver : Isolation
Field Power	Supply voltage : 24VDC typical (Max. 32VDC) Field Power Range is different depending on URI module series. Refer to URI module's specification.
Max. Current Field Power Contact	DC 10A Max
Weight	162g
Module Size	54mm x 99mm x 70mm

Wiring Diagram

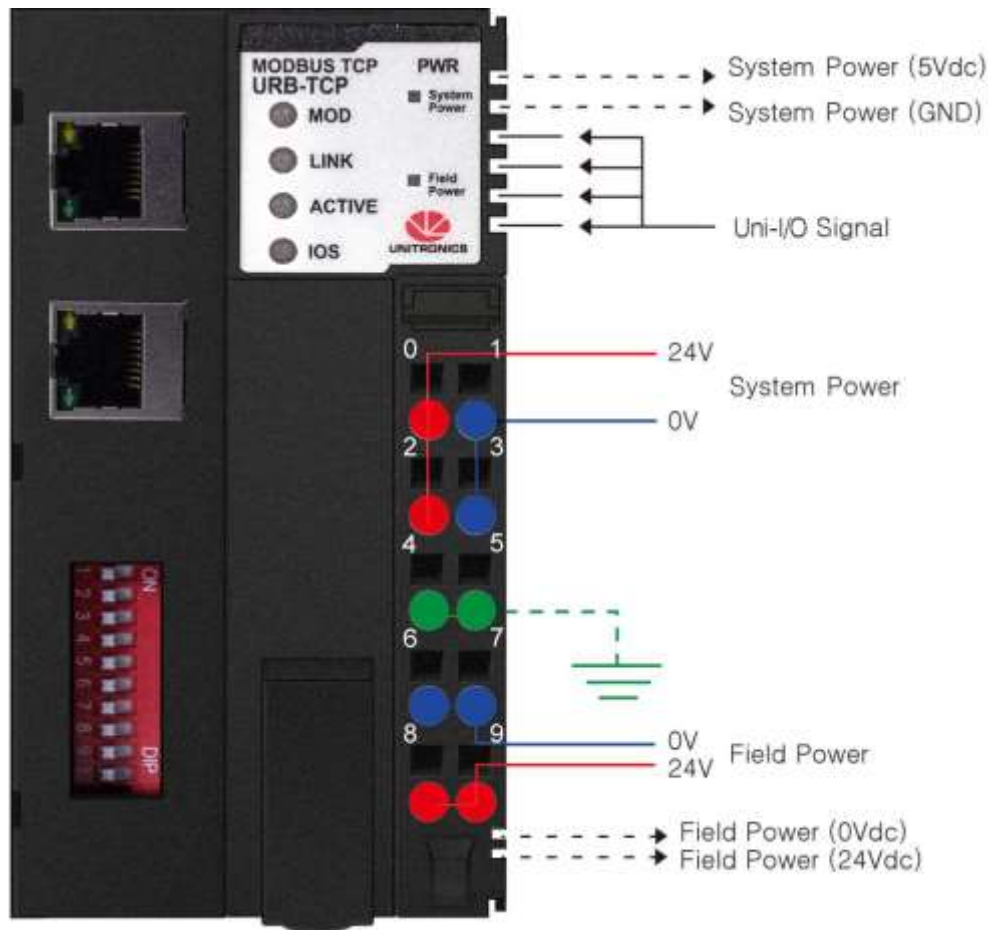

Pin No.	Signal Description	Pin No.	Signal Description
0	System Power, 24V	1	System Power, Ground
2	System Power, 24V	3	System Power, Ground
4	F.G	5	F.G
6	Field Power, Ground	7	Field Power, Ground
8	Field Power, 24V	9	Field Power, 24V

RJ45 Socket

RJ-45	Signal Name	Description
1	TD+	Transmit +
2	TD-	Transmit -
3	RD+	Receive +
4	-	
5	-	
6	RD-	Receive -
7	-	
8	-	
Case	Shield	

DIP Switch

DIP Pole No.	Role	Description
1	IP bit#0	Lowest IP Address octet when Pole#10=ON Example: XXX.XXX.XXX.IP
2	IP bit#1	
3	IP bit#2	
4	IP bit#3	
5	IP bit#4	
6	IP bit#5	
7	IP bit#6	
8	IP bit#7	
9	DHCP / BOOTP	Enable DHCP / BOOTP BOOTP Default, DHCP using special register 0x1045
10	Use DIP IP Value	Use IP Address set by DIP Switches

IP Address Setup using BOOTP Server

The URB adapter IP defaults are:

Default IP: 192.168.100.100

Subnet mask: 255.255.255.0

Note that on the adapter, there is a sticker showing its MAC address.

Editing the IP defaults

There are two methods of changing the IP address:

- Via UniLogic's BOOTP Server
This is a utility accessible via the UniLogic ribbon
- Via DIP switch
These are physical switches on the adapter

Selecting the IP Configuration Method

To enable the selected method, you must raise the appropriate DIP switch on the adapter. By factory default, the adapter is supplied with all switches down.

- Raise #9 to set IP via BOOTP Server:
-Enables the adapter BOOTP/DHCP

- The adapter sends 20 consecutive BOOTP/DHCP request messages every 2 seconds.
- If the BOOTP/DHCP server does not respond, the Adapter applies the latest saved IP address

- Raise #10 to set IP via DIP switch:
You can then set the IP according to the description in the next table.

URB Adapter DIP Switches

#	Role	Description
1	IP bit#0	Lowest IP Address octet when Switch #10=ON (raised) Example: XXX.XXX.XXX.IP
2	IP bit#1	
3	IP bit#2	
4	IP bit#3	
5	IP bit#4	
6	IP bit#5	
7	IP bit#6	
8	IP bit#7	
9	DHCP / BOOTP	Enable DHCP / BOOTP
10	Use DIP IP Value	Enable IP Address set by DIP Switches

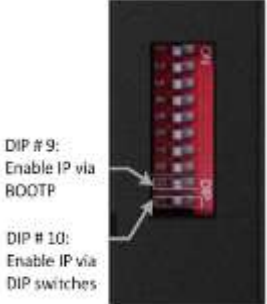

Configuring IP using Unitronics BOOTP Server

Before you can set the IP address of the Remote IO adaptor via Unitronics BOOTP Server, you must raise DIP #9 (check that #10 is down)

1. Power OFF the URB adapter.
2. Raise DIP switch #9 to enable DHCP / BOOTP.
3. In UniLogic, in the Solution Explorer, select the adapter; the ribbon will open the tab URB Remote I/O.
4. On the ribbon, click on Run BOOTP Server to open the utility.

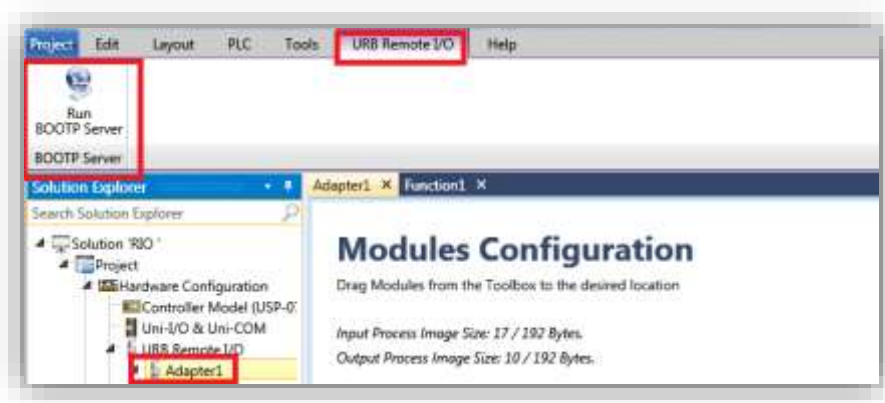

5. Click Start BootP in the **Unitronics** BOOTP Server; the upper section displays Ethernet devices that are in the network.

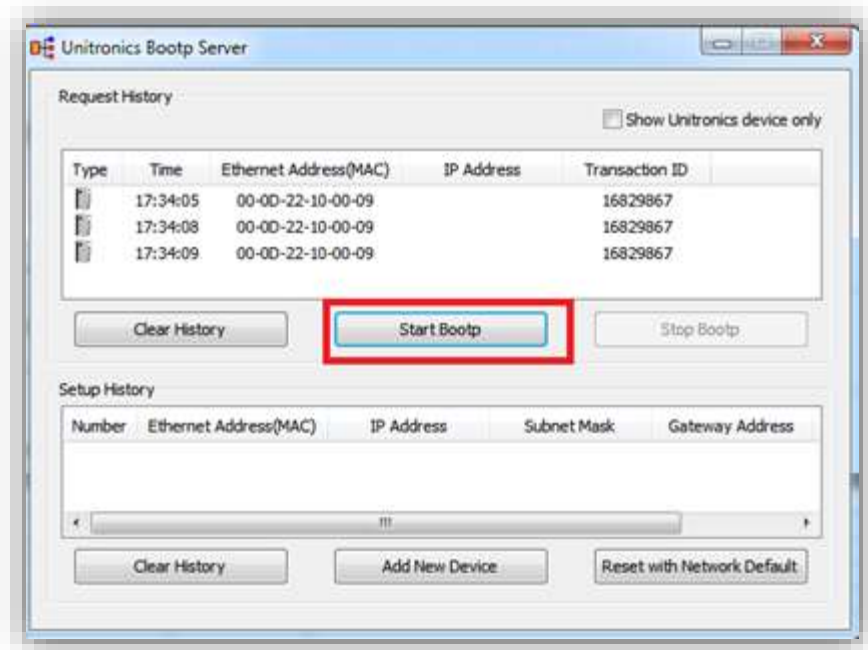

6. Power ON the URB adapter.
7. Locate the adapter's MAC address and double-click on the row.
8. Enter the required IP address and select your PC Network card.

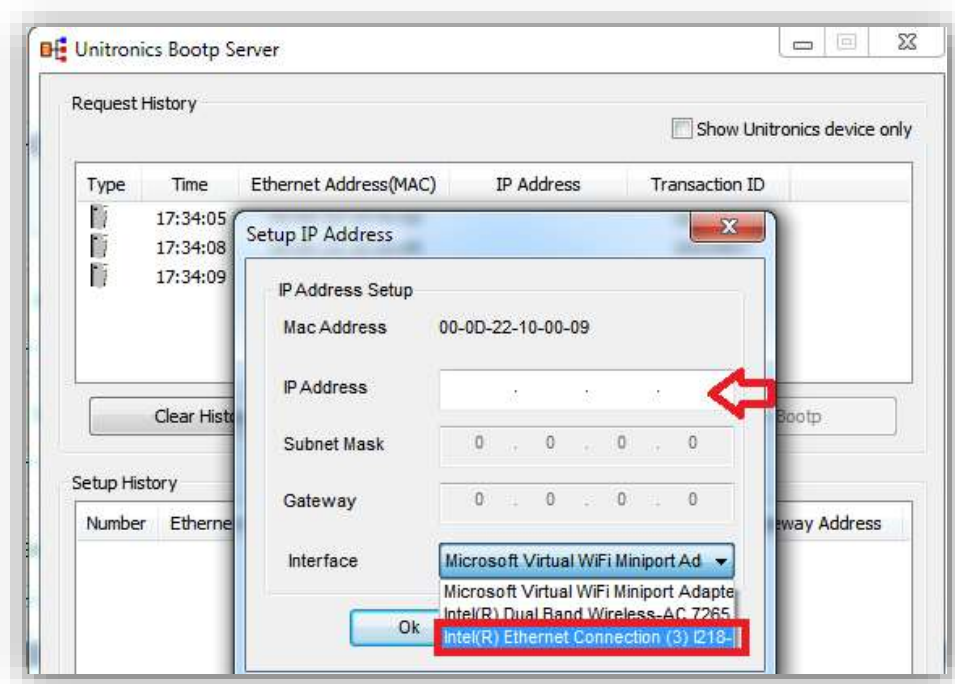

9. Click Ok. Now you should see the device in the bottom window including the IP address.

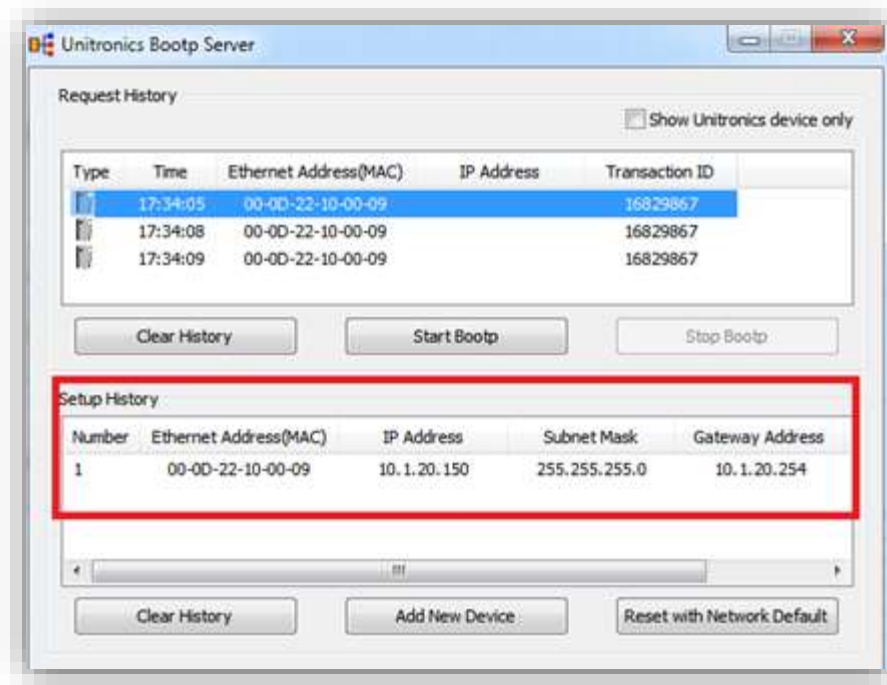

10. Power cycle the adapter; turn it off and on.
11. Use Ping from command line to check that the IP address is replying.

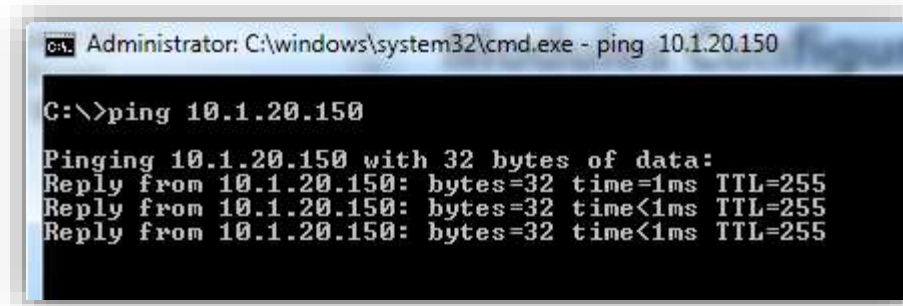

12. If the adapter replies successfully, then power off the adapter (URB-TCP) and lower DIP switch #9 (set to OFF).
13. Configure the adapter and IO modules in UniLogic and test.

LED Indicators

LED No.	LED Function / Description	LED Color
MOD	Module Status	Green/Red
LINK	Physical Connection	Green
ACTIVE	Exchange Data/Traffic Present	Green
IOS	Extension Module Status	Green/Red
System Power	System Power Enable	Green
Field Power	Field Power Enable	Green

MOD (Module Status LED)

Status	LED	Indication
Not Powered	OFF	Not power is supplied to the unit.
Device Operational	Green	The unit is operating in normal condition.
Device in Standby	Flashing Green	The device needs commissioning due to configuration missing, incomplete or incorrect.
Protocol Error	Green/Red Toggle	Protocol error such as watchdog error, etc.
Minor Fault	Flashing Red	Recoverable Fault. - EEPROM checksum fault.
Unrecoverable Fault	Red	The device has an unrecoverable fault. - Memory error or CPU watchdog error.

LINK (Physical Connection LED)

Status	LED	Indication
Not Powered or Not Linked	OFF	Device may not be powered
Adapter physical connected	Green	Adapter Ethernet Controller physically connected

ACTIVE (Exchange Data/Traffic Present LED)

Status	LED	Indication
Not Powered	OFF	Device is idle or may not be powered.
Adapter exchange data	Flashing Green	Adapter(slave) exchange data/Traffic present. About 10msec flashing.

IOS LED (Extension Module Status LED)

Status	LED	Indication
Not Powered	OFF	Device may not be powered.
No Expansion Module	Flashing Red	Adapter has no expansion module
Internal Bus Connection, Run Exchanging I/O	Green	Exchanging I/O data.
Expansion Configuration Failed	Red	One or more expansion module occurred in fault state. <ul style="list-style-type: none"> - Detected invalid expansion module ID. - Overflowed Input/Output Size - Too many expansion module - Initialization failure - Communication failure. - Changed expansion module configuration. - Mismatch vendor code between adapter and expansion module.

Field Power, System Power LED (Field Power, System Power Status LED)

Status	LED	Indication
No field, System power	OFF	Not supplied 24VDC field power, 5VDC system power.
Supplied field, System power	Green	Supplied 24VDC field power, 5VDC system power.